

02.11 Aufbau Holzzarge

Futterteile bestehen aus 22mm, Bekleidung aus 12mm Spanplatten. Falzbekleidung zur Wand auf 16mm gefaltet, Eckverbindung auf Gehrung, Zierbekleidung mit Wandstärkenausgleich -5 bis +15mm.

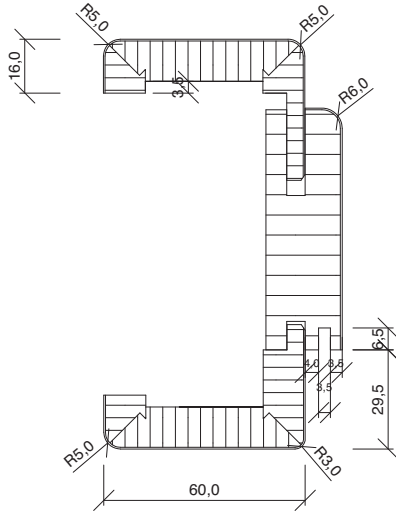

Zarge rund FU-RF

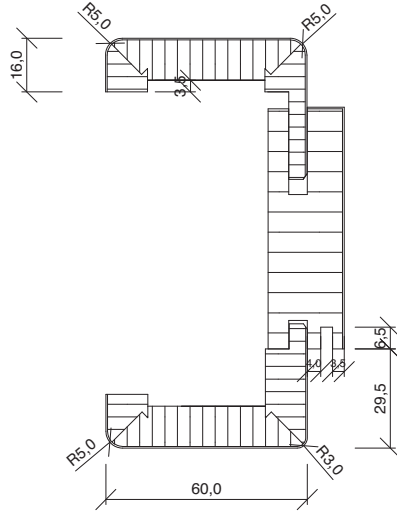

Zarge rund FU-RU

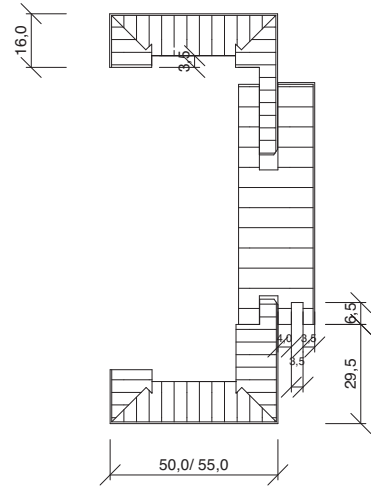

Zarge eckig FU-EC

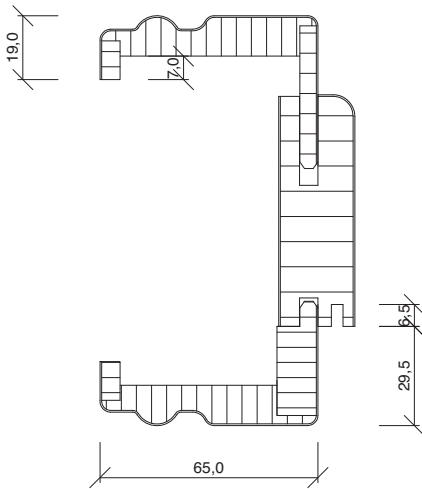

Zarge profiliert FU-PR

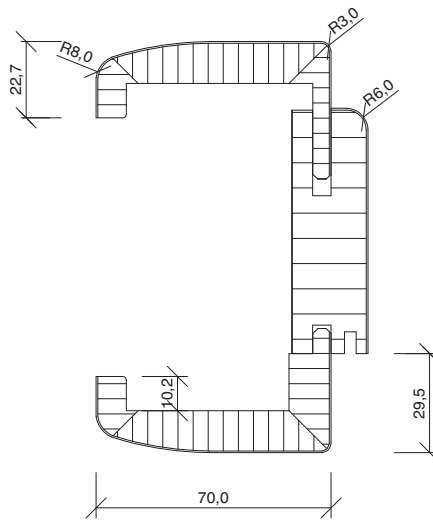

Zarge Softline FU-SLF

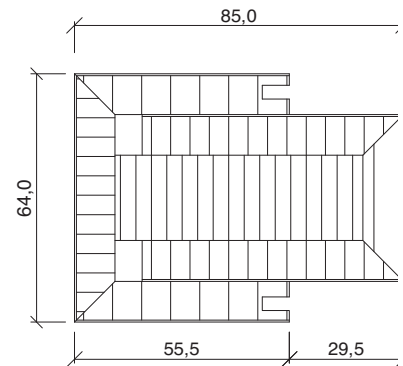

Kämpfer/ Pfosten gefaltet

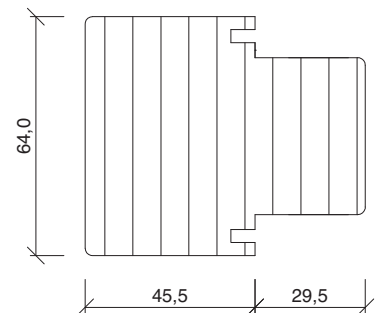
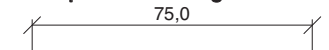

Kämpfer/ Pfosten ummantelt

Maßgruppe		Türblatt 1-flügelig			
Rohbau- öffnung	b1	635	760	885	1010
	h1	2005/ 2130	2005/ 2130	2005/ 2130	2005/ 2130
Türblatt- maß	b2	610	735	860	985
	h2	1985/ 2011	1985/ 2110	1985/ 2110	1985/ 2110
lichtes Maß	b3	569	694	819	944
	h3	1970/ 2095	1970/ 2095	1970/ 2095	1970/ 2095
Futter- außen- maß	b4	615	740	865	990
	h4	1993/ 2118	1993/ 2118	1993/ 2118	1993/ 2118

